



**Glass Passivated Super Fast Rectifiers**  
**Reverse Voltage 50 to 600 Volts Forward Current 20 Amperes**

**Features**

- Low Forward Voltage.
- Low Switching noise.
- High Current Capability
- Low Power Loss & High efficiency.
- For use in low voltage, high frequency inverter, free wheeling, and polarity protection application

**Mechanical Data**

- Case :JEDEC ITO-220AB molded plastic body
- Epoxy : UL 94V-0 rate flame retardant
- Termals: Pure tin plated , lead free. solderable per MIL-STD-202, Method 208 quaranted
- High temperature soldering guaranteed:260°C/10 seconds 0.25",(6.35mm) from case.
- Polarity:As marked
- Mounting Torqure: 4-6kg.cm
- Weight:2.24 g approx.

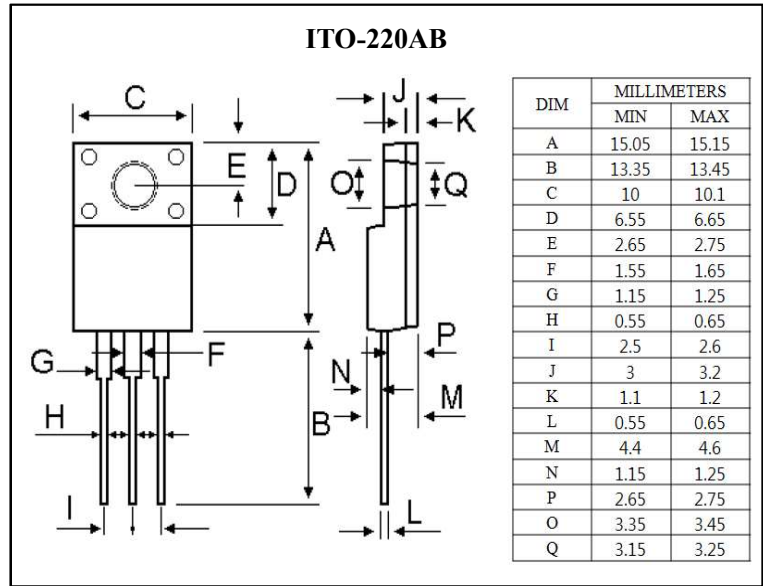

**Marking**

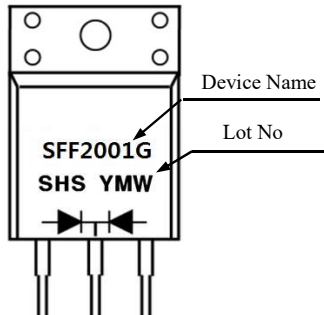

**Equivalent Circuit**

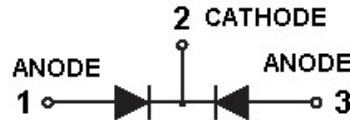

**Maximum Ratings & Electrical Characteristics**

Ratings at 25°C ambient temperature unless otherwise specified  
Single phase half wave 60 Hz, resistive or inductive load  
For capacitive load, derate current by 20%

Parameter	Symbol	SFF 2001G	SFF 2002G	SFF 2003G	SFF 2004G	SFF 2005G	SFF 2006G	SFF 2007G	SFF 2008G	Unit	Remark
Maximum Repetitive Peak Reverse Voltage	$V_{RRM}$	50	100	150	200	300	400	500	600	V	
Maximum RMS Voltage	$V_{RMS}$	35	70	105	140	210	280	350	420	V	
Maximum DC Blocking Voltage	$V_{DC}$	50	100	150	200	300	400	500	600	V	
Maximum Average Forward Rectified Current	$I_F(AV)$	20								A	
Peak Forward Surge Current, 8.3 ms Single Half Sine-wave Superimposed on Rated Load (JEDEC Method)	$I_{FSM}$	150								A	
Maximum Instantaneous Forward Voltage @5.0A	$V_F$	0.975			1.3		2.0			V	
Maximum DC Reverse Current at Rated DC Blocking Voltage	$I_R$	10								uA	Ta=25°C
		400								uA	Ta=100°C
Maximum Reverse Recovery Time	$t_{rr}$	35								ns	Note 1
Typical Junction Capacitance	$C_J$	90								pF	Note 2
Typical Thermal Resistance	$R_{th(j-c)}$	2.5								°C /W	Note 3
Operation Junction Temperature Range	$T_J$	-65 to +150								°C	
Storage Temperature Range	$T_{STG}$	-65 to +150								°C	

Note 1. Reverse Recovery Test Conditions :  $I_F=0.5A$ ,  $I_R=1.0A$ ,  $I_{RR}=0.25A$   
 Note 2. Measured at 1MHz and Applied Reverse Voltage of 4.0Volts D.C.  
 Note 3. Thermal Resistance from Junction to Case Mounted on Heatsink



Ratings and Characteristics Curves (Ta=25°C unless otherwise noted)

Fig.1 Forward Current Derating Curve

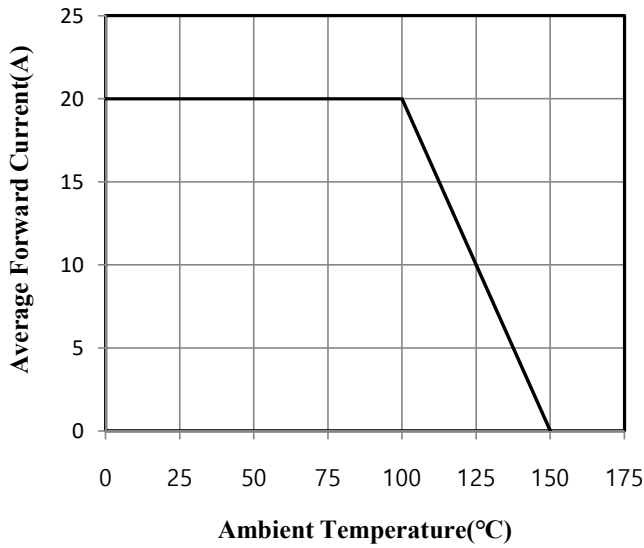

Fig.2 Maximum Non-Repetitive Peak Forward Surge Current

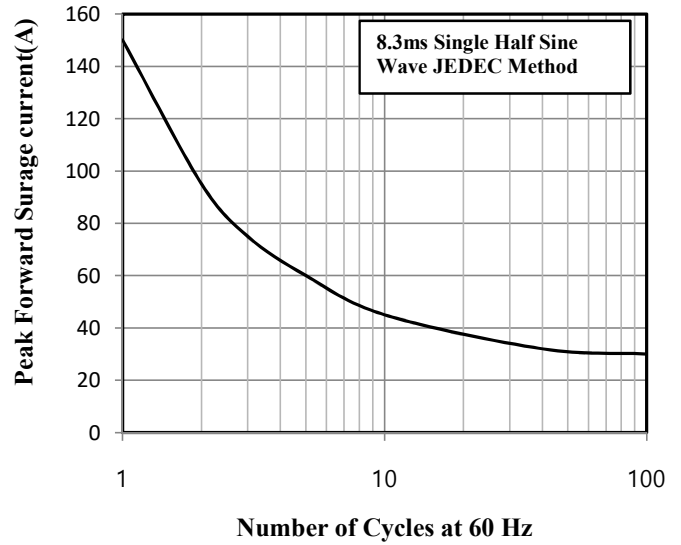

Fig.3 Typical Instantaneous Forward Characteristics

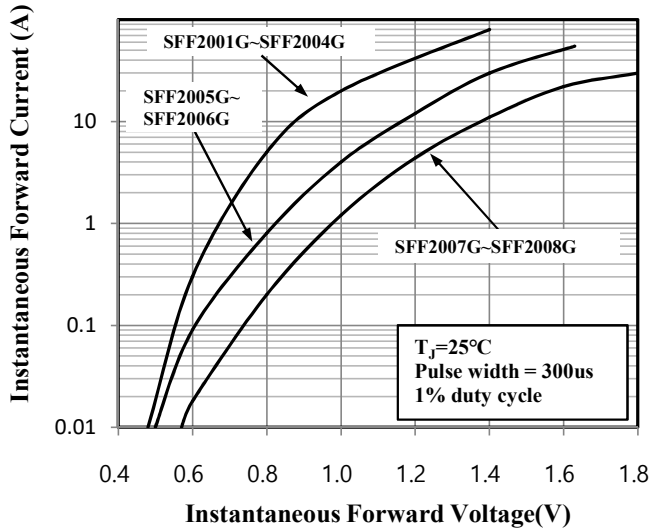

Fig.4 Typical Junction Capacitance

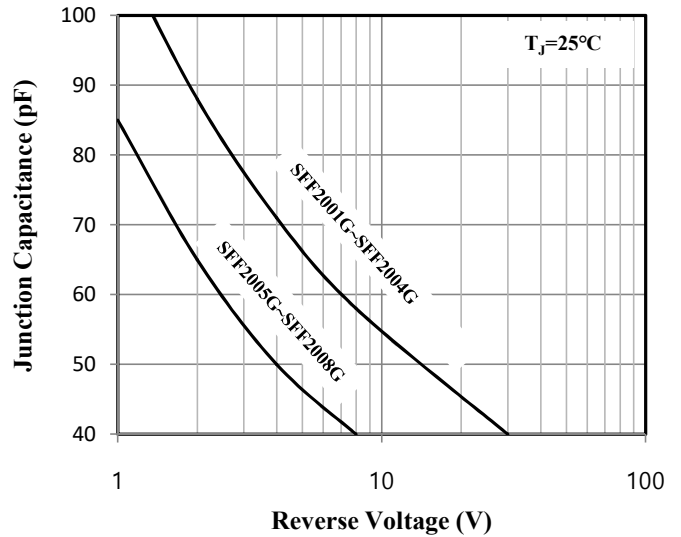

Fig.5 Typical Reverse Characteristics

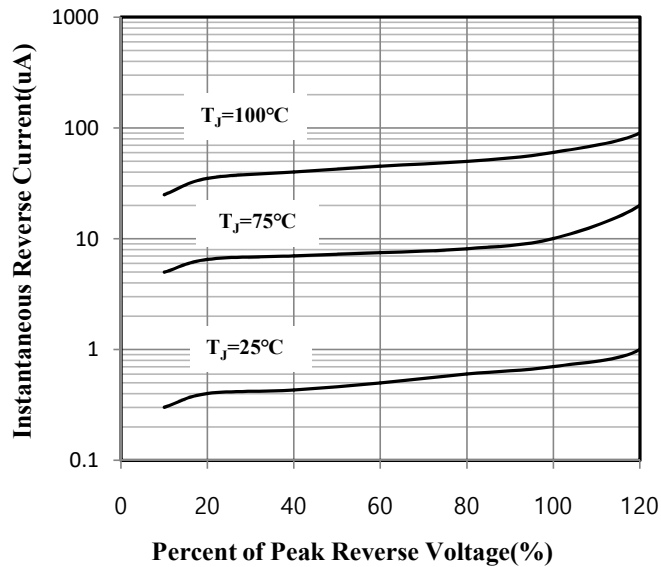

Fig. 6 Reverse Recovery Time Characteristic and Test Circuit Diagram

